

# 5439.800-GA.T090

X

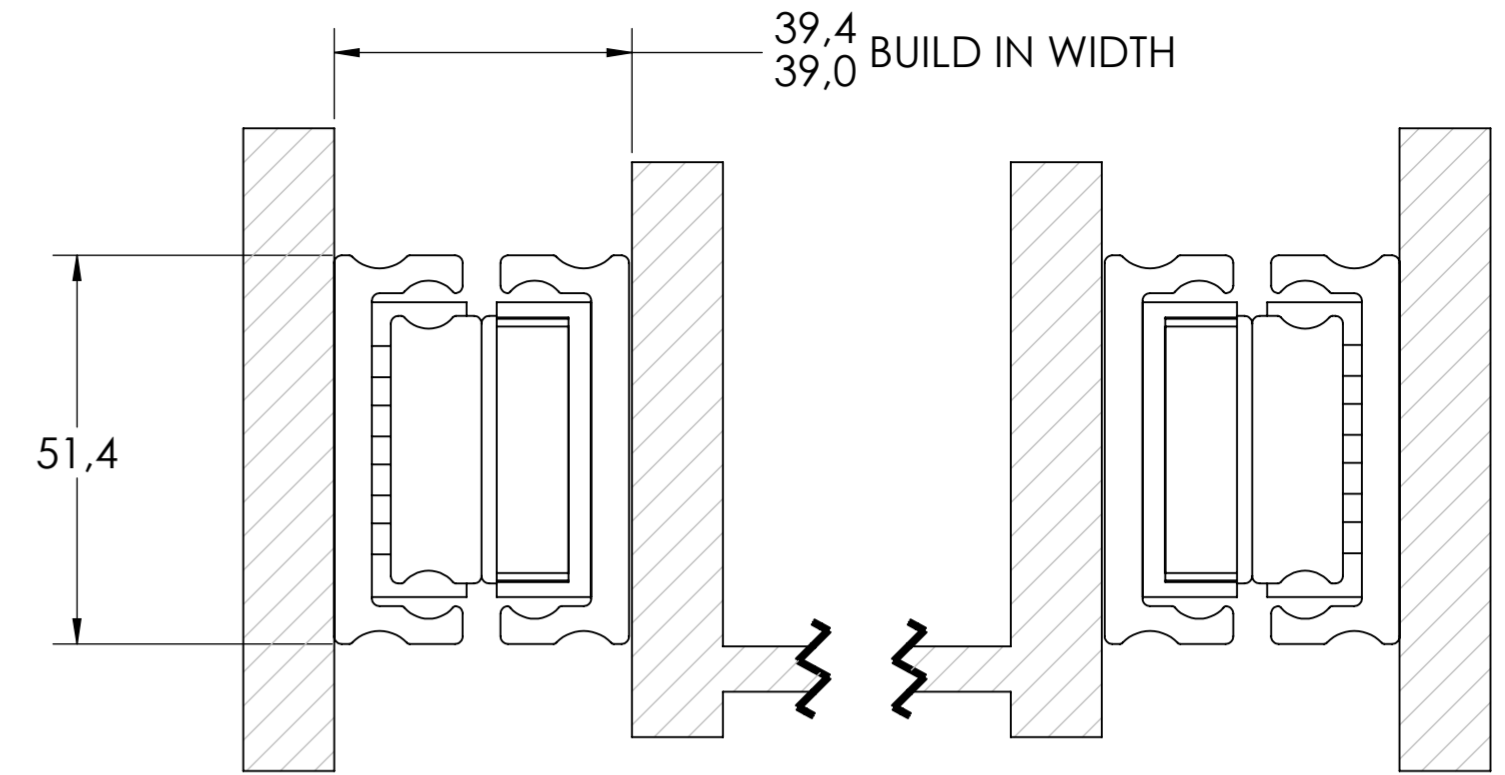

SCALE 1:1

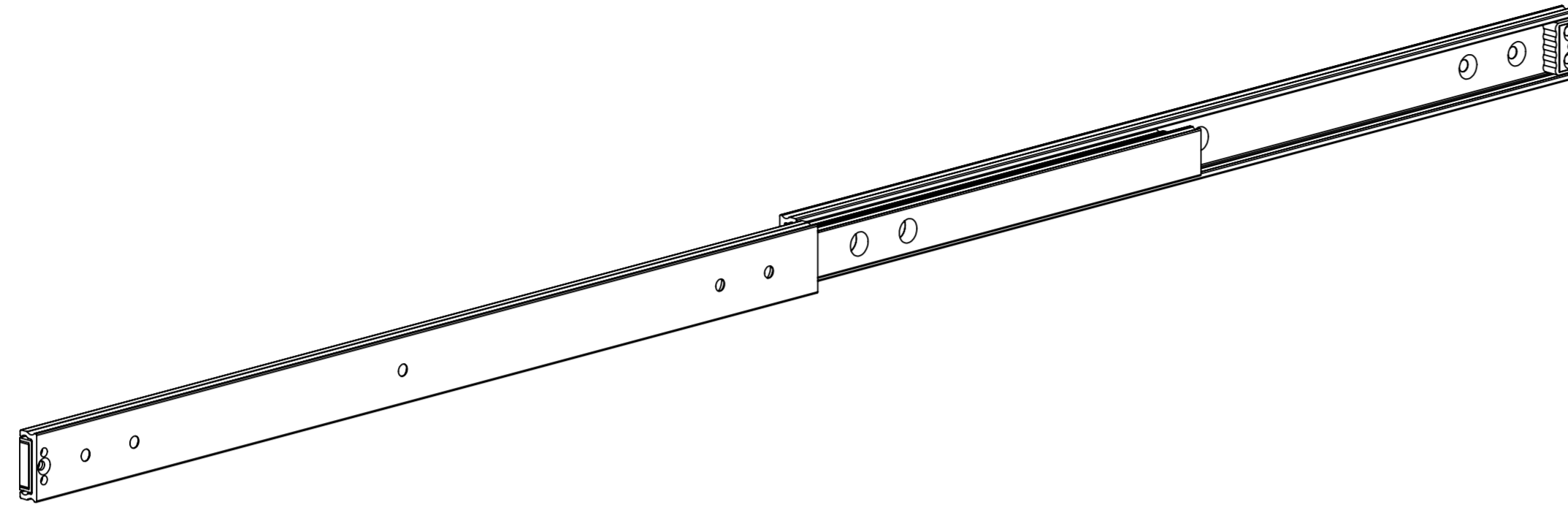
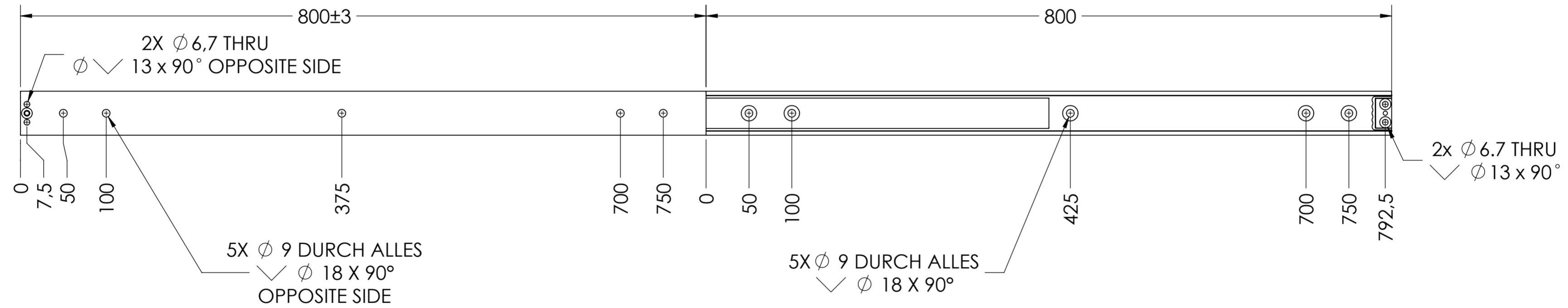
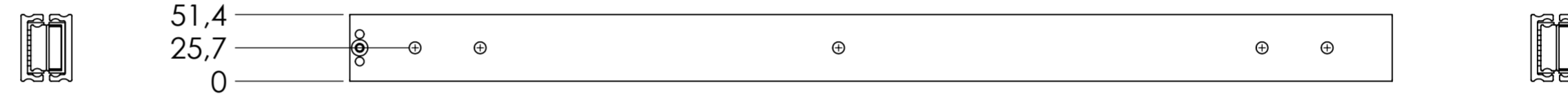

RECOMMENDED HARDWARE:  
CABINET- M8 OR M6 FLATHEAD SCREWS  
DRAWER- M8 OR M6 FLATHEAD SCREWS

general tolerances		DIN ISO 128-30 missing dimensions see 3D = theor. intersection	
ISO 2768-m			
This drawing remains our property and may not be multiplied neither be disclosed to third parties (§§1,3 and 5 from the copyright Act (UrhG)) covered according to DIN ISO 16016			
(k)		scale:	surface:
(l)		1:4	
(m)		date	name
(n)		drawn 17-12-2018	HB
(o)		proven 00-00-0000	00
(p)		<b>Fulterer</b>	
(q)			
(r)		Fulterer AG & Co KG A-6890 Lustenau / Austria	
(s)		Fulterer AG CH-9430 St. Margrethen	
(t)		drawing number: <b>5439.800-GA.T090</b>	
(u)		replaces version date:	
(v)	0	00-00-0000	0
ind.	changes	date	na.