

drawn on the left (mirrored on the right)

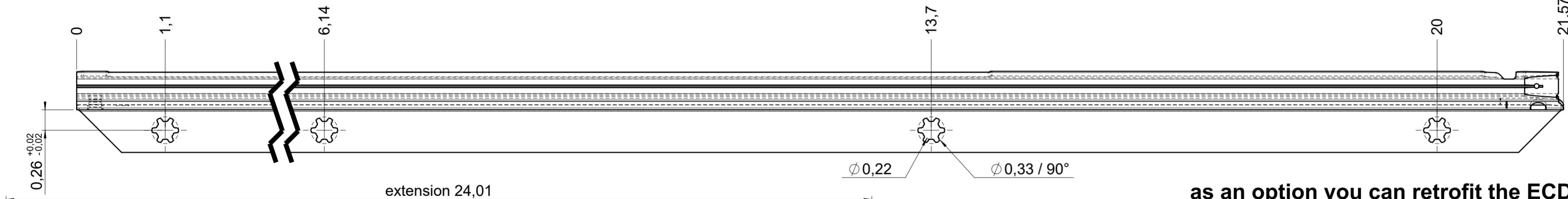

as an option you can retrofit the ECD

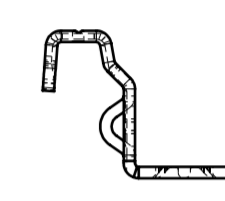
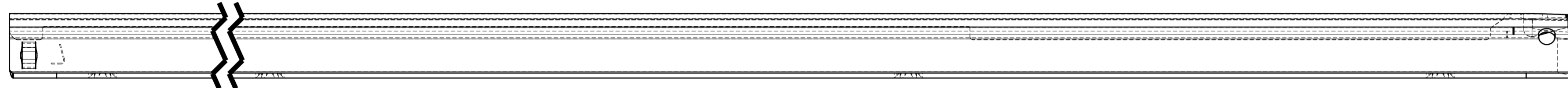
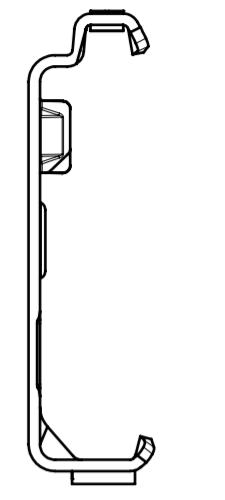
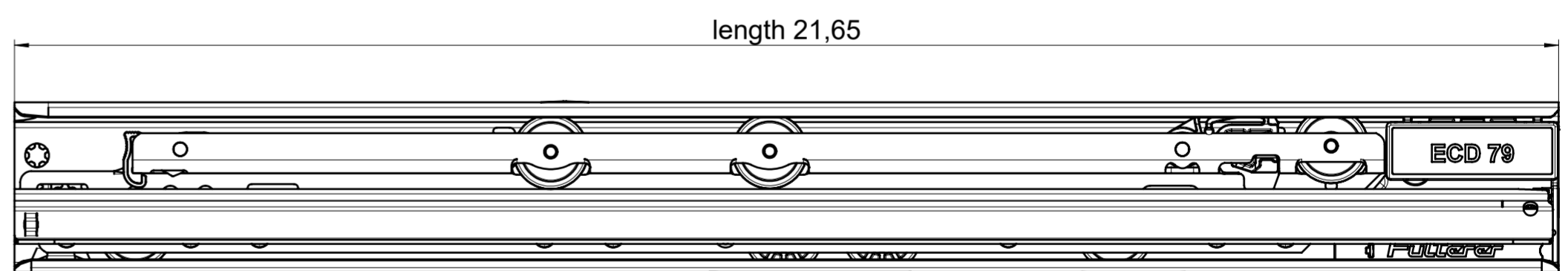
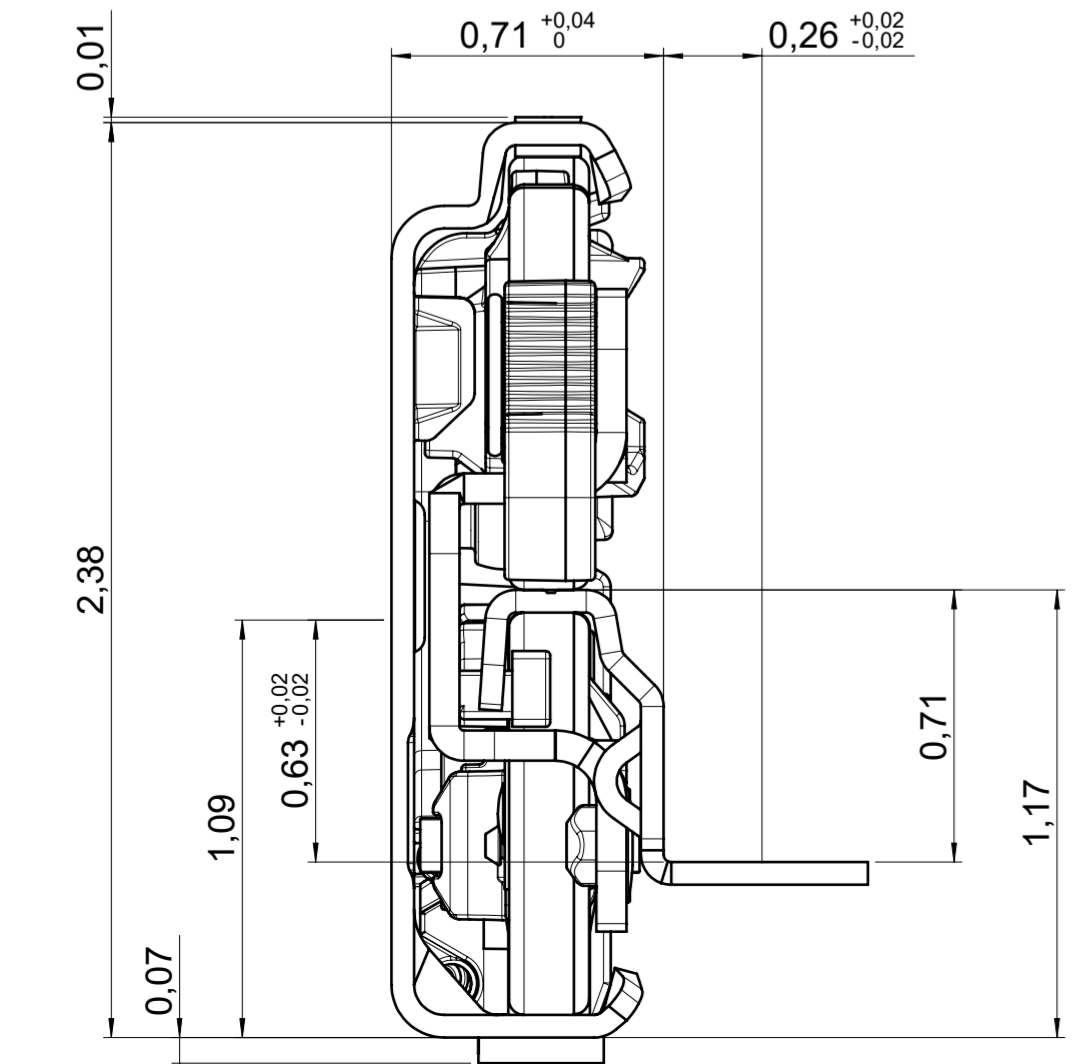
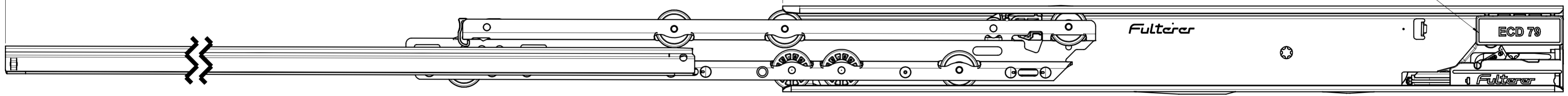

final approval

customer name:

signed by:

date:

all dimensions in inch			
missing dimensions see 3D ⇒ = theor. intersection	scale: 1:1	surface/color:	material: CS (technical requirements Fulterer)
prototype approval	drawn 2024-01-15 RK	date 2024-01-15	name RK
	description: FR 796-550 CS EN (inch) progressive-action over-extension drawerslide / bottom mount		
drawing number: CS# 796.550-GA.L500			replaces the edition:
① PDM ind. changes	2021-01-15 date	RK name	Fulterer AG & Co KG A-6890 Lustenau Fulterer AG CH-9430 St. Margrethen