

SCALE 1:1

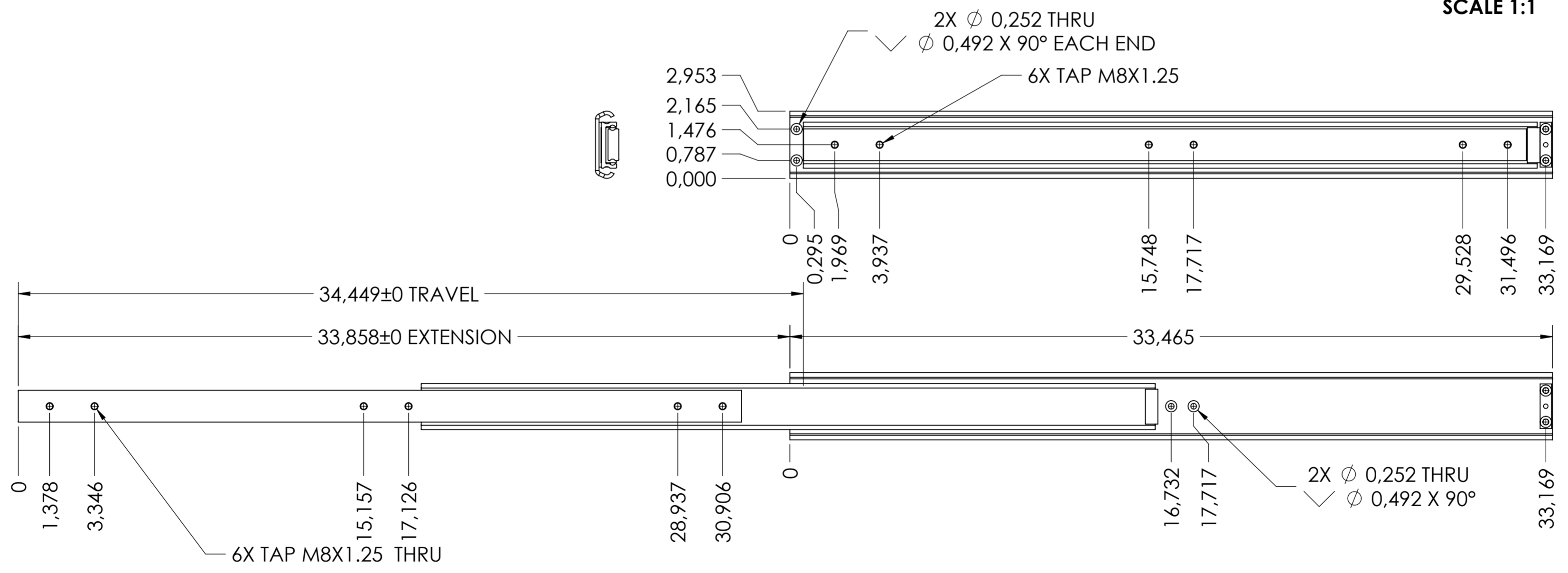

RECOMMENDED HARDWARE:
 CABINET- M6 FLATHEAD SCREWS

DRAWER- M8x1.25 SCREWS

general tolerances		DIN ISO 128-30 missing dimensions see 3D = theor. intersection	
ISO 2768-m			
This drawing remains our property and may not be multiplied neither be disclosed to third parties (§§1,3 and 5 from the copyright Act (UrhG)) covered according to DIN ISO 16016			
scale: 1:4		surface: A2	
drawn: 20-07-2018		name: HB	
proven: 00-00-0000		description: FULL EXTENSION SIDE MOUNT SUPER HEAVY DUTY SLIDE NON-DISCONNECT	
		drawing number: 5426.850-GA.T092	
		replaces version date:	
ind. 0	changes	date 00-00-0000	na. 0